

GENERAL PURPOSE

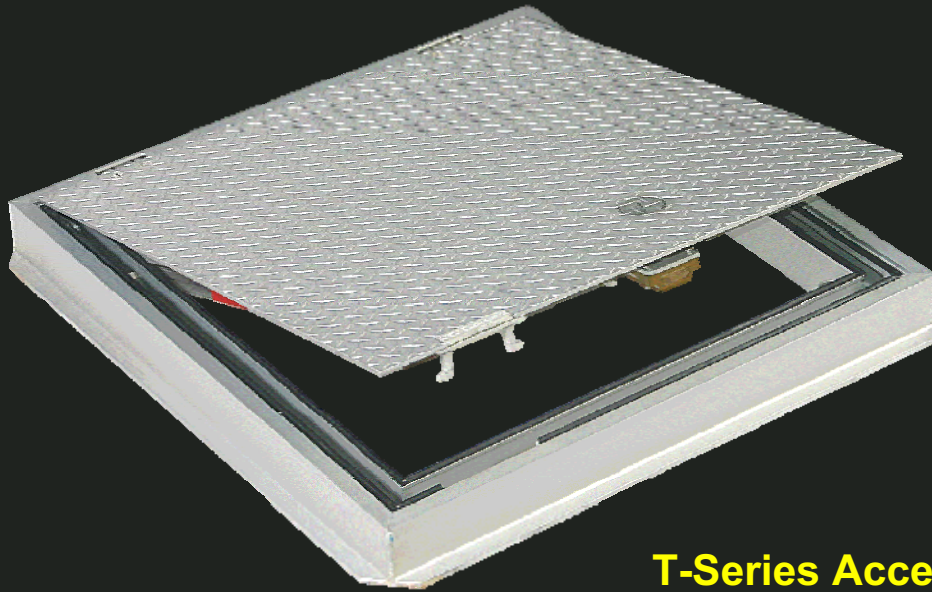

T-Series Access Hatches

Trough Frame, Aluminum, Pedestrian or H-20 Vehicle Load Ratings, Single, Double and Multiple Covers. Model TPS shown with optional recessed cylinder lock.

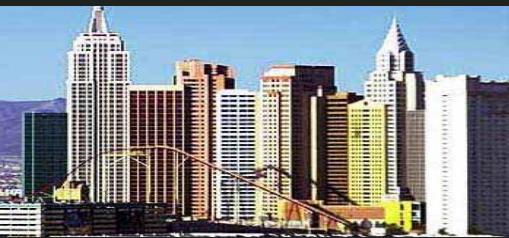

Specify T-Series trough frame access hatches as a universal solution for sidewalk, floor and utility applications where rainwater control is a requirement.

*Options include
hinged safety grate*



Manufacturing a complete line of engineered metal products for the construction industry, we set the standard for quality, service and innovation. For product specifications and details, visit:

www.usffab.com



Manufacturing in the USA since 1916

U.S.F. Fabrication, Inc., Hialeah, Florida USA 1-800-258-6873 Fax: 305-882-1577 service@usffab.com
Outside USA & Canada: 1-305-364-8221 Fax: 1-305-512-7721 export@usffab.com

T-SERIES GENERAL PURPOSE HATCHES

Trough Frame, Aluminum

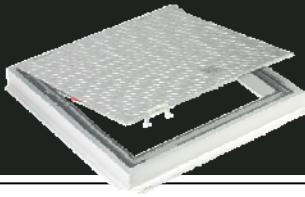

Model TPS & TPD
Pedestrian Load Rating

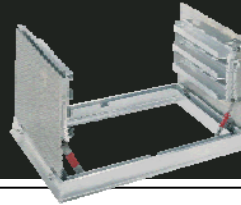

Model THS & THD
H-20 Vehicle Load Rating
(Double Cover Shown)

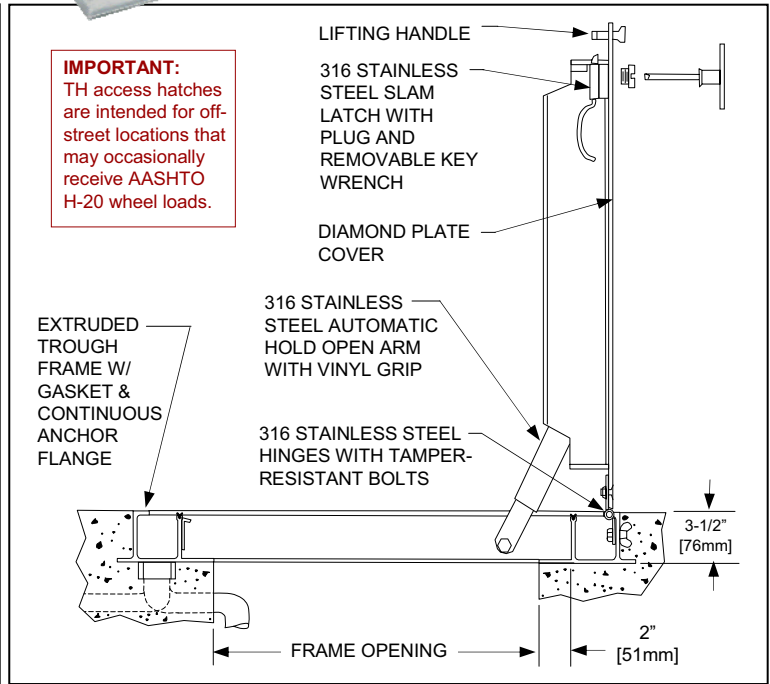
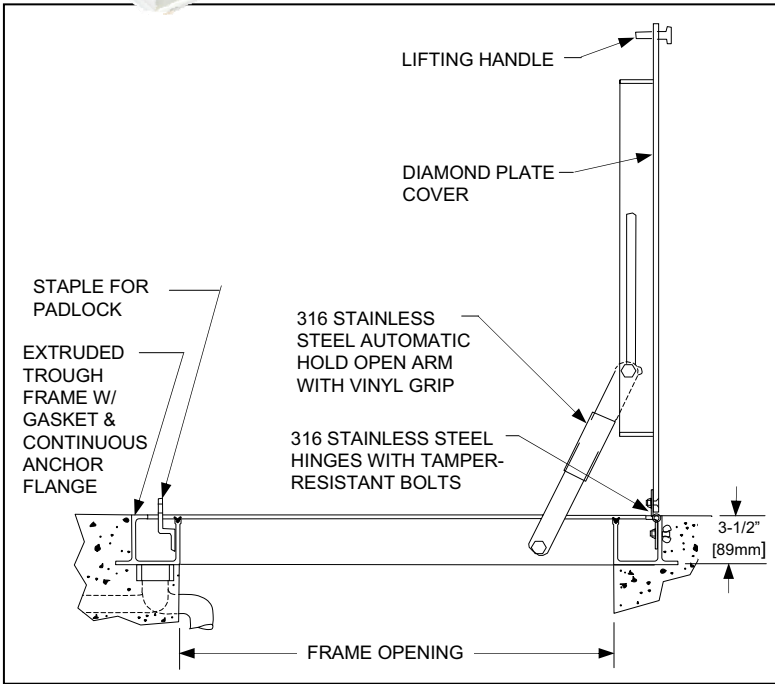

IMPORTANT:
TH access hatches are intended for off-street locations that may occasionally receive AASHTO H-20 wheel loads.

SPECIFICATIONS

The access hatch shall be Model (select from chart) as manufactured by U.S.F. Fabrication, Inc., Hialeah, Florida with the size being specified on the plans.

Cover: Cover shall be 1/4" [6mm] aluminum diamond plate (see chart for load rating). Cover shall be equipped with a flush lifting handle and 316 stainless steel hold-open arm with red vinyl grip that automatically locks the cover in the 90 degree open position.

Frame: Trough frame shall be extruded aluminum with 1-1/2" [38mm] threaded drain coupling, odor-reducing gasket, and continuous anchor flange on all four sides.

Hinges: 316 stainless steel hinges with 316 stainless steel tamper-resistant bolts/locknuts.

Latch: AP hatches shall include a staple for user-supplied padlock. AH hatches shall include a 316 stainless steel slam latch with plug and removable key wrench

Finish: Cover and frame shall be mill finish aluminum. Hardware shall be 316 stainless steel. Cover and frame shall have an adhesive backed vinyl material that protects the product during shipping and installation.

Installation: Installation shall be in accordance with the manufacturer's instructions.

Warranty: The hatch shall be manufactured in the United States. Manufacturer shall guarantee against defects in materials and workmanship for a period of ten [10] years.

OPTIONS

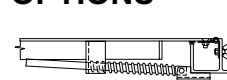

Horizontal Springs
(open or enclosed)

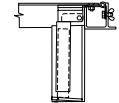

Bolt-on Vertical Springs
(open or enclosed)



Debris / Odor Control Gasket

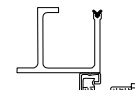

Nut Rail
(with sliding nuts)

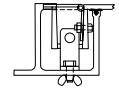

Recessed Padlock Staple

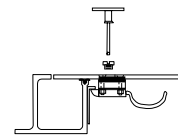

Slam Latch (stainless, standard on THS & THD)

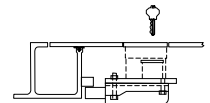

Recessed Cylinder Lock
(with threaded lid)

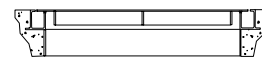

Frame Skirt to match slab thickness for easy precasting

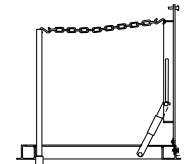

Posts and Chains
(on TPS and THS)



Hinged Safety Grate

- Additional Options:**
- Bituminous Paint
 - Anodized Finish
 - Slip Resistant Surface bonded to Cover Plate
 - Insulation under Cover

STANDARD SIZES (Custom sizes and load ratings available. Steel units also available.)

Single Cover	Model TPS	Model THS
	300 PSF Load Rating	H-20 Load Rating
FRAME OPENING Width x Hinge Side In [mm]	WEIGHT Lbs [KG]	
24 x 24 [610 x 610]	60 [27]	80 [36]
24 x 30 [610 x 762]	69 [31]	n/a
24 x 36 [610 x 914]	77 [35]	109 [49]
30 x 30 [762 x 762]	79 [36]	108 [49]
30 x 36 [762 x 914]	88 [40]	124 [56]
30 x 48 [762 x 1219]	108 [49]	156 [71]
36 x 36 [914 x 914]	99 [45]	142 [64]
36 x 48 [914 x 1219]	121 [55]	n/a
42 x 42 [1067 x 1067]	123 [56]	n/a

Double Cover	Model TPD	Model THD
	300 PSF Load Rating	H-20 Load Rating
FRAME OPENING Width x Hinge Side In [mm]	WEIGHT Lbs [KG]	
30 x 48 [762 x 1219]	115 [52]	173 [78]
30 x 54 [762 x 1372]	124 [56]	191 [87]
36 x 48 [914 x 1219]	129 [59]	198 [90]
36 x 60 [914 x 1524]	152 [69]	241 [109]
42 x 48 [1067 x 1219]	144 [65]	230 [104]
48 x 48 [1219 x 1219]	158 [72]	252 [114]
48 x 54 [1219 x 1372]	173 [78]	279 [127]
48 x 72 [1219 x 1829]	215 [98]	365 [166]
60 x 60 [1524 x 1524]	223 [101]	373 [169]

U.S.F. Fabrication, Inc., Hialeah, Florida USA 1-800-258-6873 Fax: 305-882-1577 Web: usffab.com Email: service@usffab.com
Outside USA & Canada: 1-305-364-8221 Fax: 1-305-512-7721 Email: export@usffab.com

